

Model G7T-127 W/IEC Electric Motor Rotary Gear Pump Unit

Pump Unit Include:

- Model G7T-127 Rotary gear pump FM Approved.
- UL listed or Non-listed TEFC Type Electric Motor*.
- Curved Jaw Elastomer Coupling.
- Carbon Steel Coupling Guard RAL3000(standard) or other color on request.
- Carbon Steel Base Plate, RAL3000(standard) or other color on request.

* Junction Box located on top or side of motor

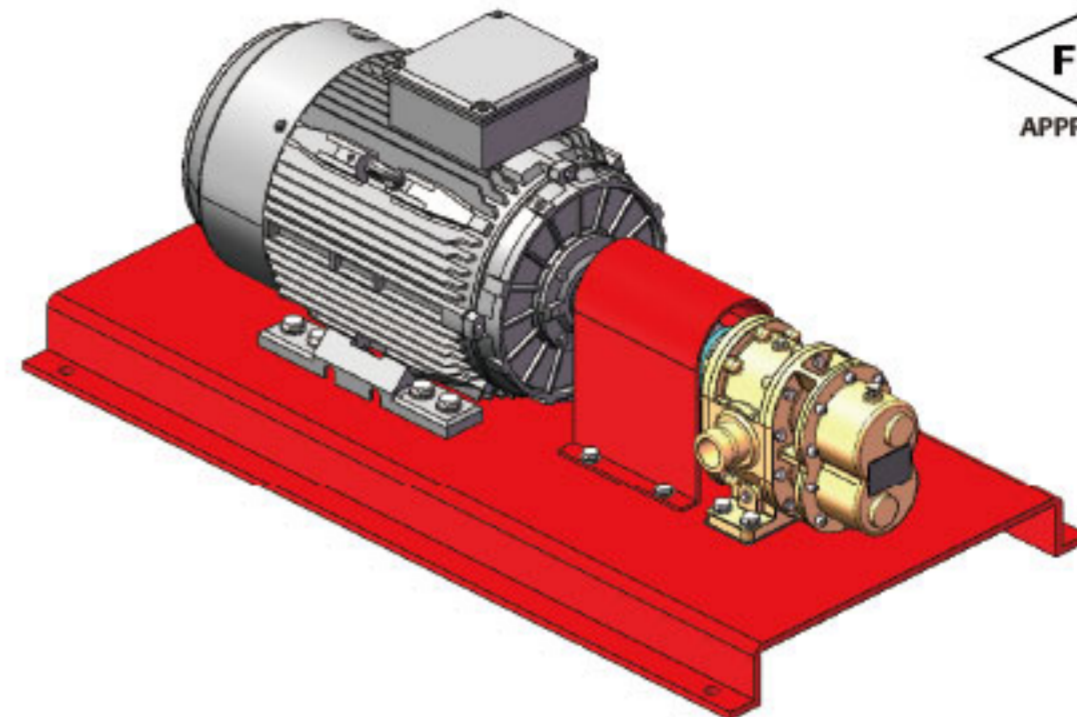

Technical Data:

Speed:	1450RPM
Connection Dia:	DN80(88.9mm O.D)
Connection Type:	Groove, Flange, Thread
Voltage:	380V/3P/50HZ
Enclosure:	IP 56

Performance

Speed	G7T-127	
1500rpm	Flow Rate (Water)	Power
Pressure	L/min	Kw
5.0	737.6	13.00
5.5	734.7	13.80
6.0	731.8	14.62
6.5	729.0	15.43
7.0	726.3	16.25
7.5	723.7	17.06
8.0	721.1	17.87
8.5	718.7	18.67
9.0	716.3	19.46
9.5	714.0	20.24
10.0	711.8	21.00
10.5	709.7	21.74
11.0	707.6	22.46
11.5	705.7	23.17
12.0	703.8	23.87
12.5	702.0	24.56
13.0	700.3	25.25
13.5	698.7	25.93
14.0	697.1	26.62
14.5	695.7	27.30
15.0	694.3	28.00
15.5	693.1	28.71
16.0	691.9	29.42
16.5	690.8	30.16
17.0	689.8	30.91
17.5	688.9	31.69
18.0	688.0	32.49
18.5	687.3	33.32
19.0	686.7	34.18
19.5	686.1	35.07
20.0	685.7	36.00

Speed	G7T-127	
1500rpm	Flow Rate (Foam)	Power
Pressure	L/min	Kw
5.0	733.3	16.00
5.5	728.7	16.55
6.0	724.3	17.10
6.5	720.0	17.66
7.0	715.9	18.23
7.5	712.1	18.81
8.0	708.4	19.41
8.5	705.1	20.02
9.0	702.1	20.66
9.5	699.5	21.31
10.0	697.2	22.00
10.5	695.5	22.71
11.0	694.1	23.46
11.5	693.0	24.22
12.0	692.3	25.01
12.5	691.9	25.81
13.0	691.6	26.63
13.5	691.5	27.46
14.0	691.6	28.30
14.5	691.7	29.15
15.0	691.8	30.00
15.5	691.9	30.85
16.0	692.0	31.70
16.5	691.9	32.54
17.0	691.7	33.37
17.5	691.3	34.19
18.0	690.6	34.99
18.5	689.6	35.78
19.0	688.3	36.54
19.5	686.6	37.29
20.0	684.4	38.00

Model G7T-127 W/IEC Electric Motor Rotary Gear Pump Unit

Dimensions

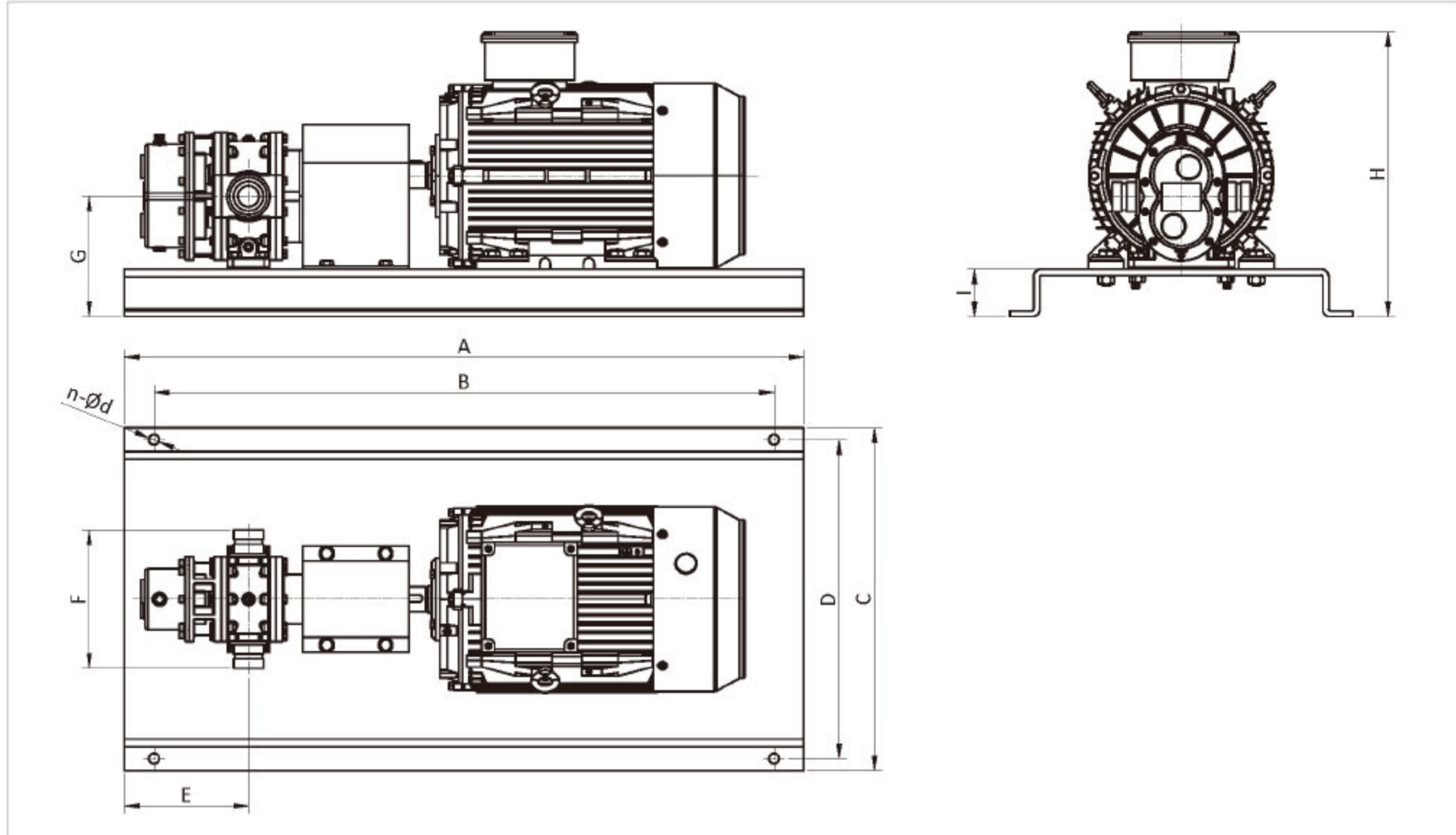

Model	Power	A	B	C	D	E	F	G	H	I	n	d
G7T	Kw	mm	mm	mm	mm	mm	mm	mm	mm	mm	-	mm
	15.0	1320	1220	580	540	290	285	232	526	80	4	18
	18.5	1350	1250	630	590	290	285	232	547	80	4	18
	22.0	1390	1290	630	590	290	285	232	547	80	4	18
	30.0	1440	1340	700	660	290	285	232	582	80	4	18
	37.0	1470	1370	760	720	290	285	285	637	80	4	18
	45.0	1500	1400	760	720	290	285	285	637	80	4	18